

IRG7PH42UDPbF IRG7PH42UD-EP

INSULATED GATE BIPOLAR TRANSISTOR WITH ULTRAFAST SOFT RECOVERY DIODE

Features

- Low $V_{CE(ON)}$ trench IGBT technology
- Low switching losses
- Square RBSOA
- 100% of the parts tested for I_{LM} ①
- Positive $V_{CE(ON)}$ temperature co-efficient
- Ultra fast soft recovery co-pak diode
- Tight parameter distribution
- Lead-Free

Benefits

- High efficiency in a wide range of applications
- Suitable for a wide range of switching frequencies due to low $V_{CE(ON)}$ and low switching losses
- Rugged transient performance for increased reliability
- Excellent current sharing in parallel operation

Applications

- U.P.S.
- Welding
- Solar Inverter
- Induction Heating

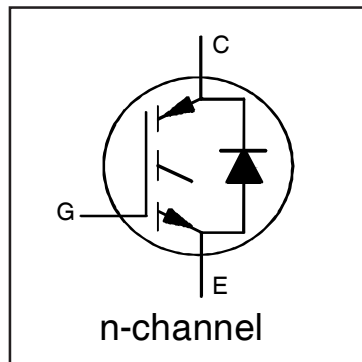

$V_{CES} = 1200V$
$I_C = 45A, T_C = 100^\circ C$
$T_{J(max)} = 150^\circ C$
$V_{CE(on)} \text{ typ.} = 1.7V$

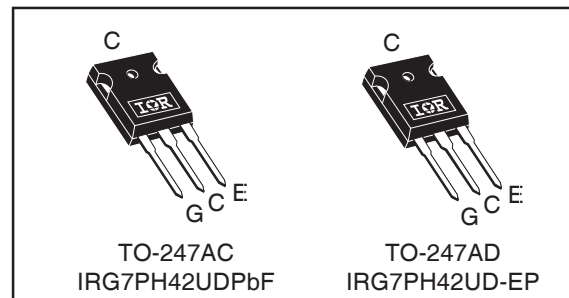

G	C	E
Gate	Collector	Emitter

Absolute Maximum Ratings

	Parameter	Max.	Units
V_{CES}	Collector-to-Emitter Voltage	1200	V
$I_C @ T_C = 25^\circ C$	Continuous Collector Current (Silicon Limited)	85 ^③	A
$I_C @ T_C = 100^\circ C$	Continuous Collector Current (Silicon Limited)	45	
$I_{NOMINAL}$	Nominal Current	30	
I_{CM}	Pulse Collector Current, $V_{GE} = 15V$	90	
I_{LM}	Clamped Inductive Load Current, $V_{GE} = 20V$ ①	120	
$I_F @ T_C = 25^\circ C$	Diode Continuous Forward Current	85	
$I_F @ T_C = 100^\circ C$	Diode Continuous Forward Current	45	
I_{FM}	Diode Maximum Forward Current ②	120	
V_{GE}	Continuous Gate-to-Emitter Voltage	± 30	V
$P_D @ T_C = 25^\circ C$	Maximum Power Dissipation	320	W
$P_D @ T_C = 100^\circ C$	Maximum Power Dissipation	130	
T_J	Operating Junction and	-55 to +150	$^\circ C$
T_{STG}	Storage Temperature Range		
	Soldering Temperature, for 10 sec.		
	Mounting Torque, 6-32 or M3 Screw	10 lbf-in (1.1 N-m)	

Thermal Resistance

	Parameter	Min.	Typ.	Max.	Units
$R_{\theta JC}$ (IGBT)	Thermal Resistance Junction-to-Case-(each IGBT) ④	—	—	0.39	$^\circ C/W$
$R_{\theta JC}$ (Diode)	Thermal Resistance Junction-to-Case-(each Diode) ④	—	—	0.56	
$R_{\theta CS}$	Thermal Resistance, Case-to-Sink (flat, greased surface)	—	0.24	—	
$R_{\theta JA}$	Thermal Resistance, Junction-to-Ambient (typical socket mount)	—	40	—	

Electrical Characteristics @ T_J = 25°C (unless otherwise specified)

	Parameter	Min.	Typ.	Max.	Units	Conditions
V _{(BR)CES}	Collector-to-Emitter Breakdown Voltage	1200	—	—	V	V _{GE} = 0V, I _C = 100μA ③
ΔV _{(BR)CES} /ΔT _J	Temperature Coeff. of Breakdown Voltage	—	0.18	—	V/°C	V _{GE} = 0V, I _C = 2.0mA (25°C-150°C)
V _{CE(on)}	Collector-to-Emitter Saturation Voltage	—	1.7	2.0	V	I _C = 30A, V _{GE} = 15V, T _J = 25°C
		—	2.1	—		I _C = 30A, V _{GE} = 15V, T _J = 150°C
V _{GE(th)}	Gate Threshold Voltage	3.0	—	6.0	V	V _{CE} = V _{GE} , I _C = 1.0mA
ΔV _{GE(th)} /ΔT _J	Threshold Voltage temp. coefficient	—	-14	—	mV/°C	V _{CE} = V _{GE} , I _C = 1.0mA (25°C - 150°C)
g _{fe}	Forward Transconductance	—	32	—	S	V _{CE} = 50V, I _C = 30A, PW = 80μs
I _{CES}	Collector-to-Emitter Leakage Current	—	4.4	150	μA	V _{GE} = 0V, V _{CE} = 1200V
		—	1200	—		V _{GE} = 0V, V _{CE} = 1200V, T _J = 150°C
V _{FM}	Diode Forward Voltage Drop	—	2.0	2.4	V	I _F = 30A
		—	2.2	—		I _F = 30A, T _J = 150°C
I _{GES}	Gate-to-Emitter Leakage Current	—	—	±100	nA	V _{GE} = ±30V

Switching Characteristics @ T_J = 25°C (unless otherwise specified)

	Parameter	Min.	Typ.	Max.	Units	Conditions
Q _g	Total Gate Charge (turn-on)	—	157	236	nC	I _C = 30A
Q _{ge}	Gate-to-Emitter Charge (turn-on)	—	21	32		V _{GE} = 15V
Q _{gc}	Gate-to-Collector Charge (turn-on)	—	69	104		V _{CC} = 600V
E _{on}	Turn-On Switching Loss	—	2105	2374	μJ	I _C = 30A, V _{CC} = 600V, V _{GE} = 15V
E _{off}	Turn-Off Switching Loss	—	1182	1424		R _G = 10Ω, L = 200μH, T _J = 25°C
E _{total}	Total Switching Loss	—	3287	3798		Energy losses include tail & diode reverse recovery
t _{d(on)}	Turn-On delay time	—	25	34	ns	
t _r	Rise time	—	32	41		
t _{d(off)}	Turn-Off delay time	—	229	271		
t _f	Fall time	—	63	86		
E _{on}	Turn-On Switching Loss	—	2978	—	μJ	I _C = 30A, V _{CC} = 600V, V _{GE} = 15V
E _{off}	Turn-Off Switching Loss	—	1968	—		R _G = 10Ω, L = 200μH, T _J = 150°C ③
E _{total}	Total Switching Loss	—	4946	—		Energy losses include tail & diode reverse recovery
t _{d(on)}	Turn-On delay time	—	19	—	ns	
t _r	Rise time	—	32	—		
t _{d(off)}	Turn-Off delay time	—	290	—		
t _f	Fall time	—	154	—		
C _{ies}	Input Capacitance	—	3338	—	pF	V _{GE} = 0V
C _{oes}	Output Capacitance	—	124	—		V _{CC} = 30V
C _{res}	Reverse Transfer Capacitance	—	75	—		f = 1.0Mhz
RBSOA	Reverse Bias Safe Operating Area	FULL SQUARE				T _J = 150°C, I _C = 120A V _{CC} = 960V, V _p = 1200V R _G = 10Ω, V _{GE} = +20V to 0V
E _{rec}	Reverse Recovery Energy of the Diode	—	1475	—	μJ	T _J = 150°C
t _{rr}	Diode Reverse Recovery Time	—	153	—	ns	V _{CC} = 600V, I _F = 30A
I _{rr}	Peak Reverse Recovery Current	—	34	—	A	R _G = 10Ω, L = 1.0mH

Notes:

- ① V_{CC} = 80% (V_{CES}), V_{GE} = 20V, L = 22μH, R_G = 10Ω.
- ② Pulse width limited by max. junction temperature.
- ③ Refer to AN-1086 for guidelines for measuring V_{(BR)CES} safely.
- ④ R_θ is measured at T_J of approximately 90°C.
- ⑤ Calculated continuous current based on maximum allowable junction temperature.
Bond wire current limit is 78A. Note that current limitations arising from heating of the device leads may occur with some lead mounting arrangements.

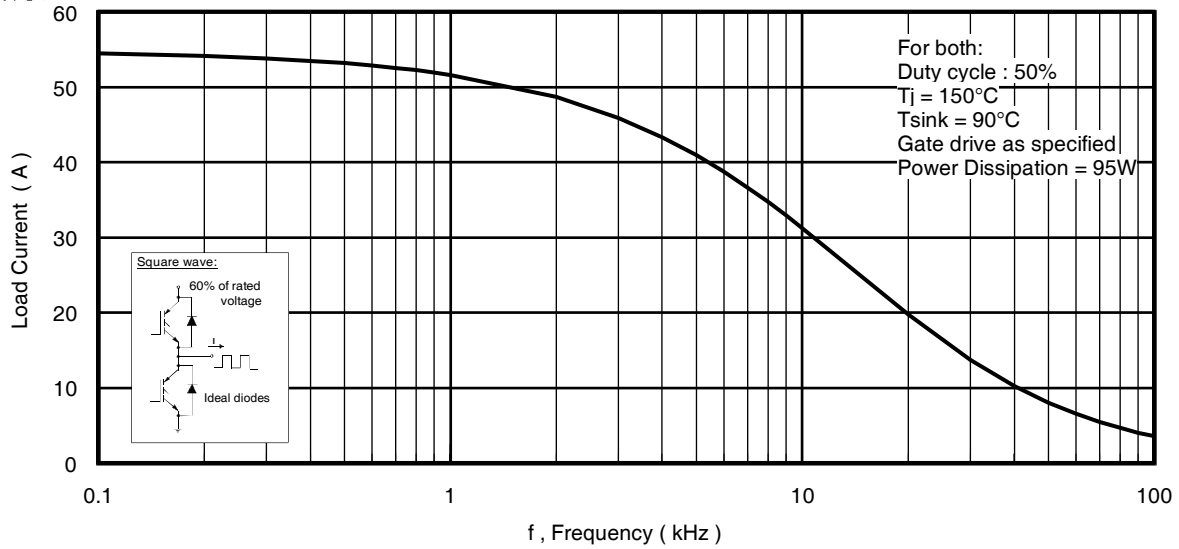

Fig. 1 - Typical Load Current vs. Frequency
(Load Current = I_{RMS} of fundamental)

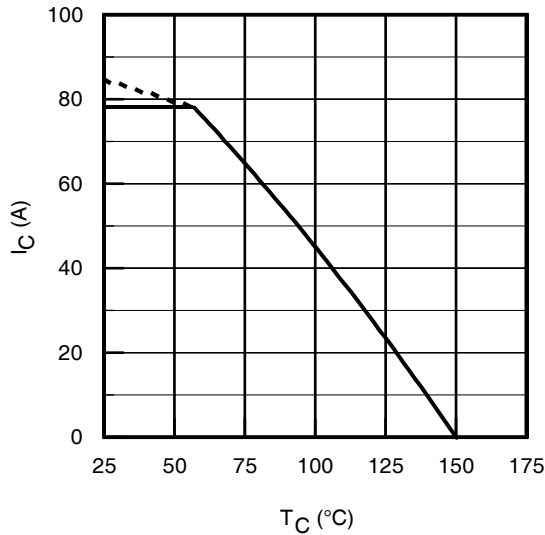

Fig. 1 - Maximum DC Collector Current vs. Case Temperature

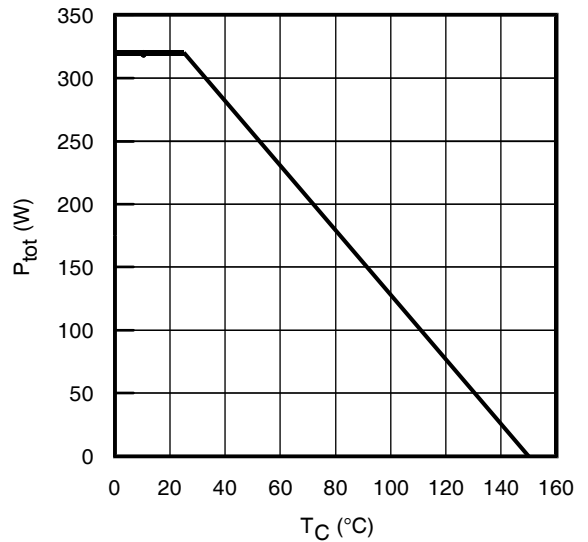

Fig. 2 - Power Dissipation vs. Case Temperature

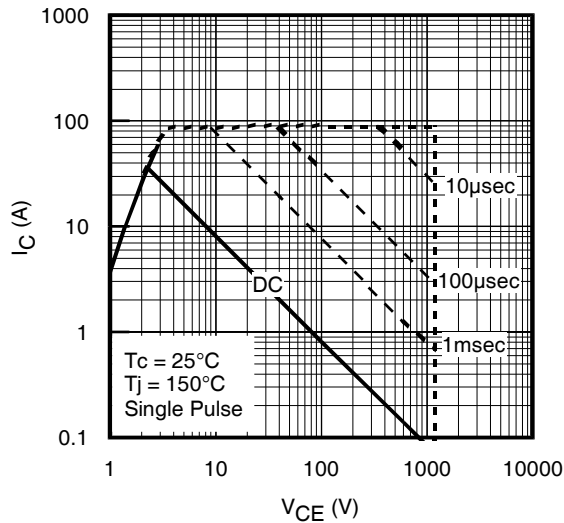

Fig. 3 - Forward SOA
 $T_C = 25^\circ\text{C}$, $T_J \leq 150^\circ\text{C}$; $V_{GE} = 15\text{V}$

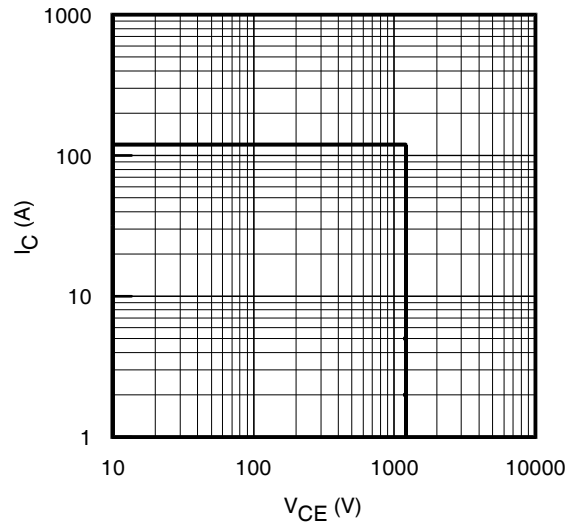

Fig. 4 - Reverse Bias SOA
 $T_J = 150^\circ\text{C}$; $V_{GE} = 20\text{V}$

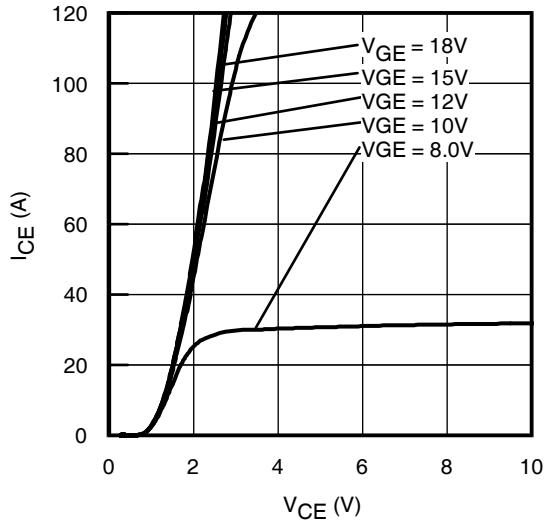

Fig. 5 - Typ. IGBT Output Characteristics
 $T_J = -40^\circ\text{C}$; $t_p = 80\mu\text{s}$

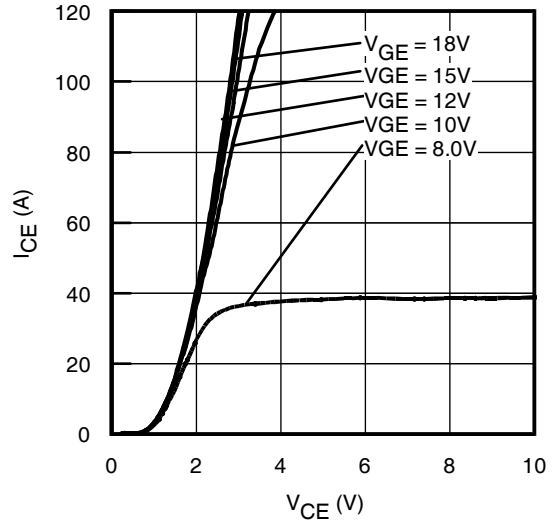

Fig. 6 - Typ. IGBT Output Characteristics
 $T_J = 25^\circ\text{C}$; $t_p = 80\mu\text{s}$

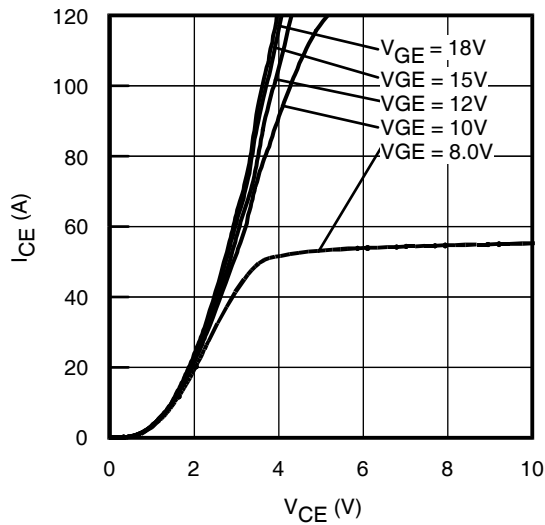

Fig. 7 - Typ. IGBT Output Characteristics
 $T_J = 150^\circ\text{C}$; $t_p = 80\mu\text{s}$

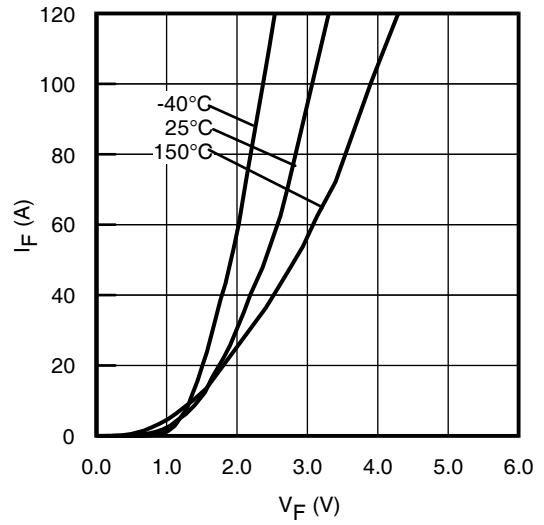

Fig. 8 - Typ. Diode Forward Characteristics
 $t_p = 80\mu\text{s}$

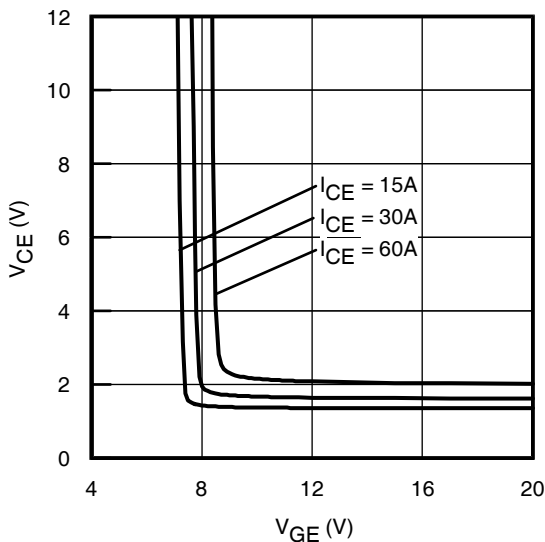

Fig. 9 - Typical V_{CE} vs. V_{GE}
 $T_J = -40^\circ\text{C}$

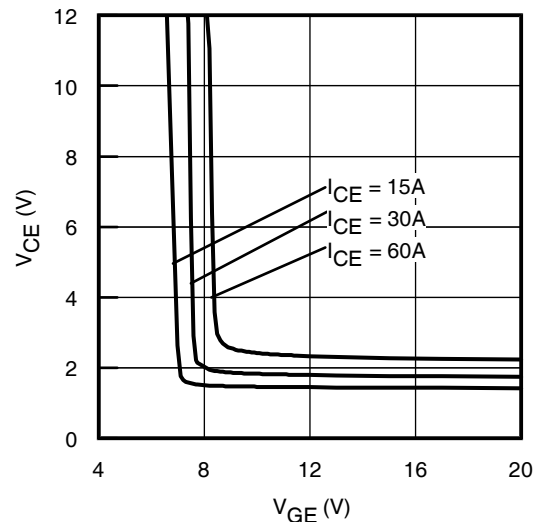

Fig. 10 - Typical V_{CE} vs. V_{GE}
 $T_J = 25^\circ\text{C}$

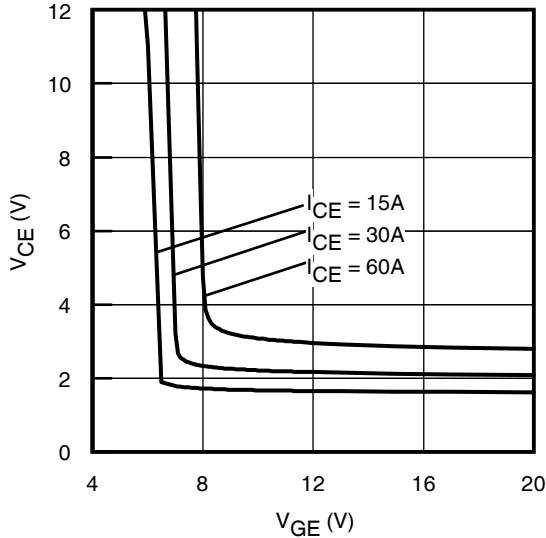

Fig. 11 - Typical V_{CE} vs. V_{GE}
 $T_J = 150^\circ\text{C}$

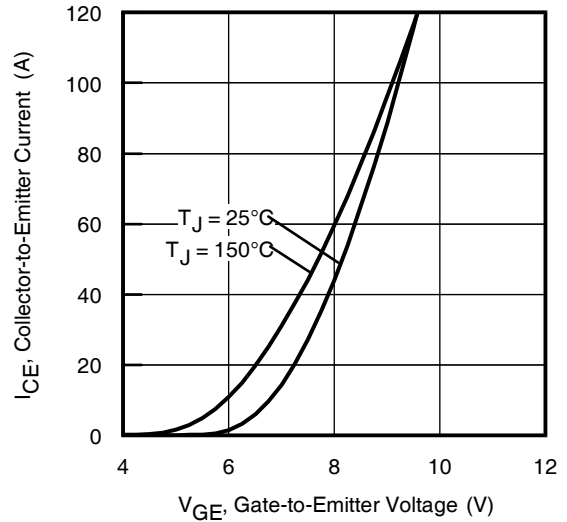

Fig. 12 - Typ. Transfer Characteristics
 $V_{CE} = 50\text{V}$

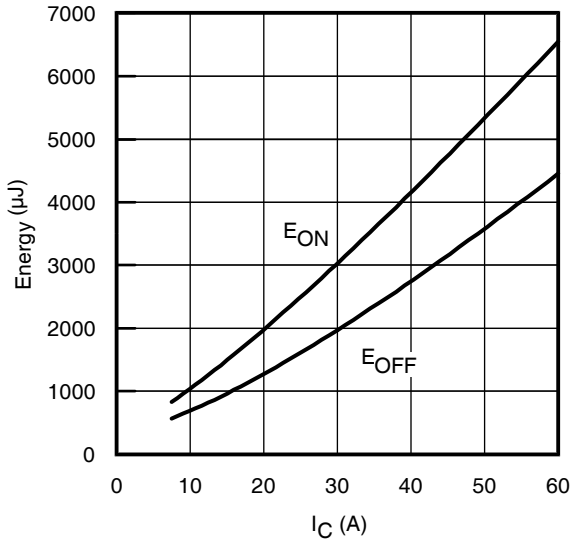

Fig. 13 - Typ. Energy Loss vs. I_C

$T_J = 150^\circ\text{C}$; $L = 200\mu\text{H}$; $V_{CE} = 600\text{V}$; $R_G = 10\Omega$; $V_{GE} = 15\text{V}$

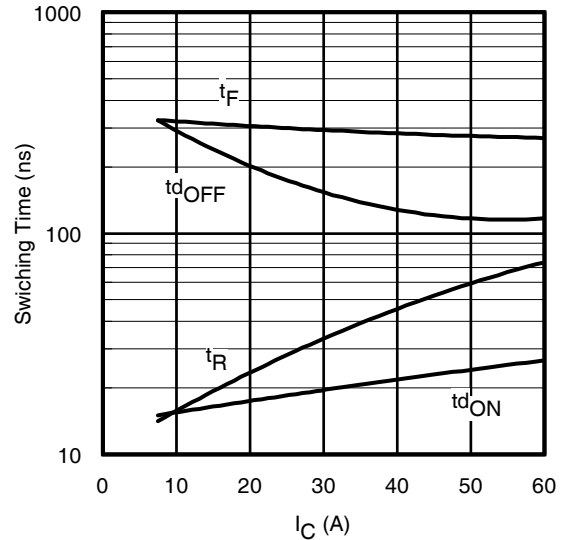

Fig. 14 - Typ. Switching Time vs. I_C

$T_J = 150^\circ\text{C}$; $L = 200\mu\text{H}$; $V_{CE} = 600\text{V}$; $R_G = 10\Omega$; $V_{GE} = 15\text{V}$

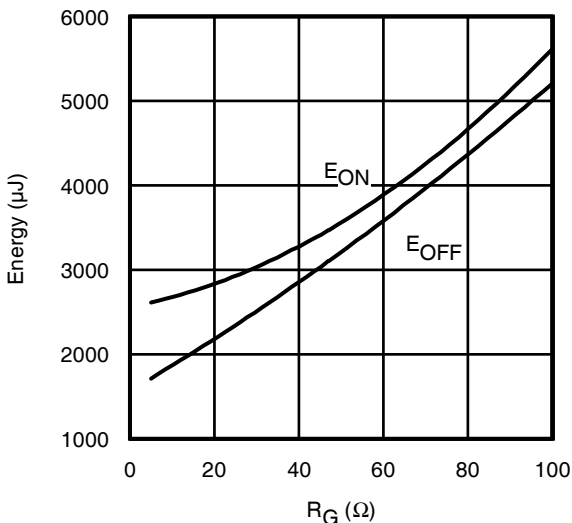

Fig. 15 - Typ. Energy Loss vs. R_G

$T_J = 150^\circ\text{C}$; $L = 200\mu\text{H}$; $V_{CE} = 600\text{V}$; $I_{CE} = 30\text{A}$; $V_{GE} = 15\text{V}$

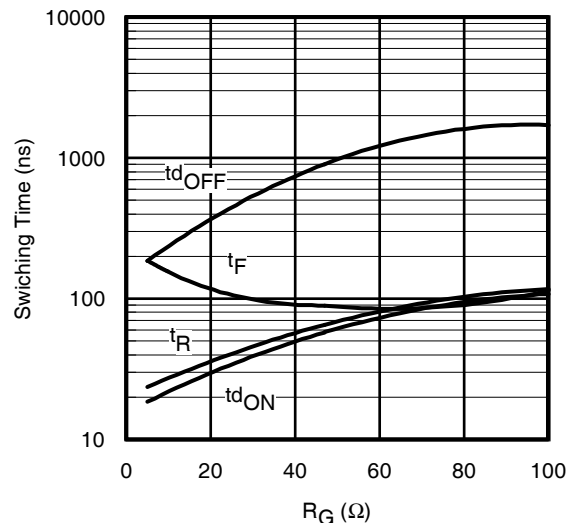

Fig. 16 - Typ. Switching Time vs. R_G

$T_J = 150^\circ\text{C}$; $L = 200\mu\text{H}$; $V_{CE} = 600\text{V}$; $I_{CE} = 30\text{A}$; $V_{GE} = 15\text{V}$

IRG7PH42UDPbF/IRG7PH42UD-EP

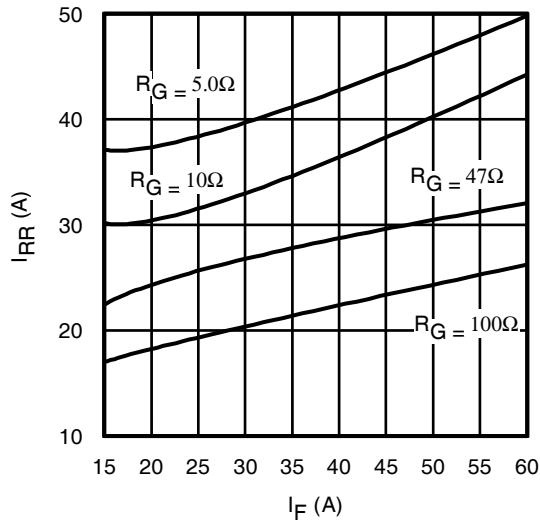

Fig. 17 - Typ. Diode I_{RR} vs. I_F
 $T_J = 150^\circ\text{C}$

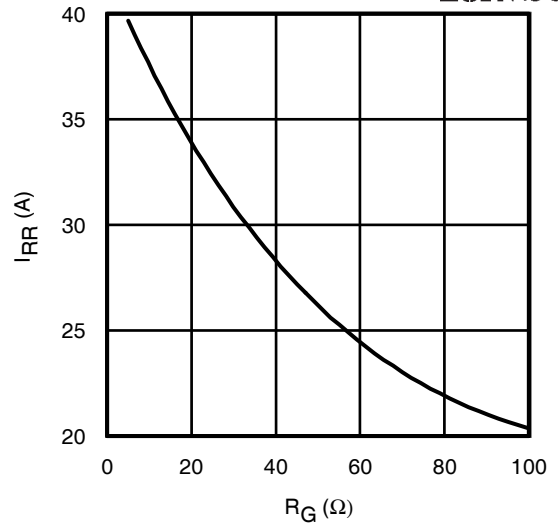

Fig. 18 - Typ. Diode I_{RR} vs. R_G
 $T_J = 150^\circ\text{C}$

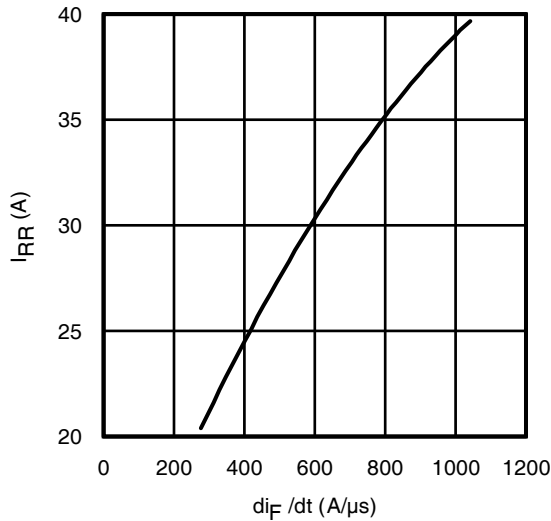

Fig. 19 - Typ. Diode I_{RR} vs. di_F/dt
 $V_{CC} = 600\text{V}$; $V_{GE} = 15\text{V}$; $I_F = 30\text{A}$; $T_J = 150^\circ\text{C}$

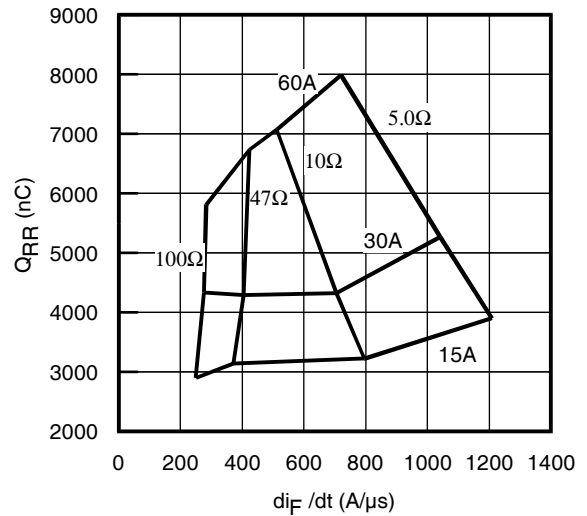

Fig. 20 - Typ. Diode Q_{RR} vs. di_F/dt
 $V_{CC} = 600\text{V}$; $V_{GE} = 15\text{V}$; $T_J = 150^\circ\text{C}$

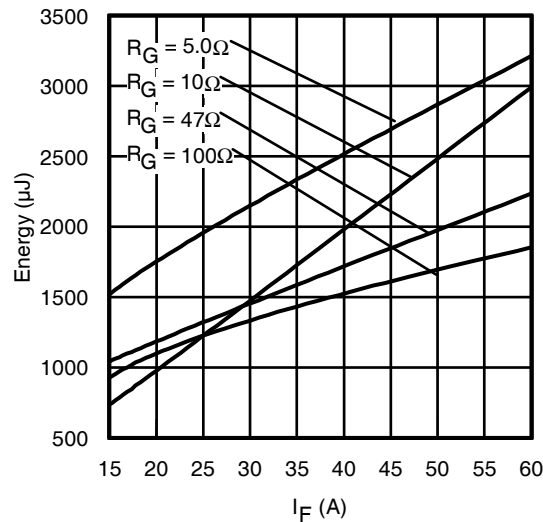

Fig. 21 - Typ. Diode E_{RR} vs. I_F
 $T_J = 150^\circ\text{C}$

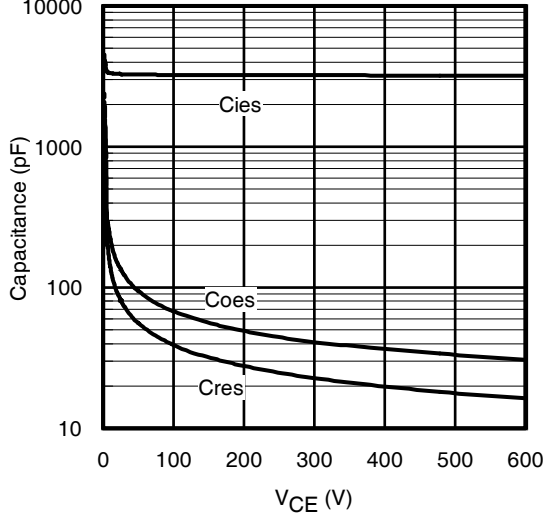

Fig. 22 - Typ. Capacitance vs. V_{CE}
 $V_{GE} = 0V$; $f = 1MHz$

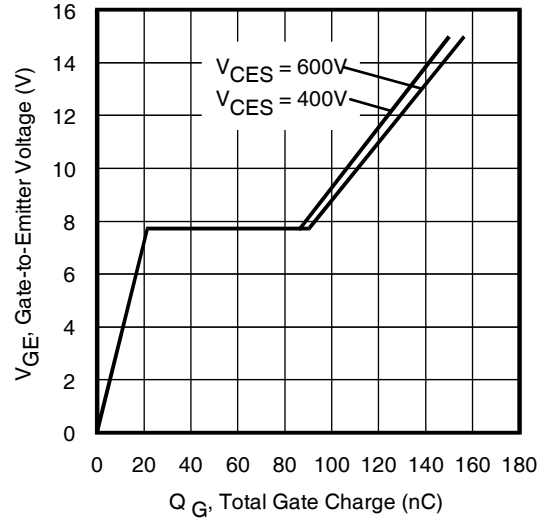

Fig. 23 - Typical Gate Charge vs. V_{GE}
 $I_{CE} = 30A$; $L = 600\mu H$

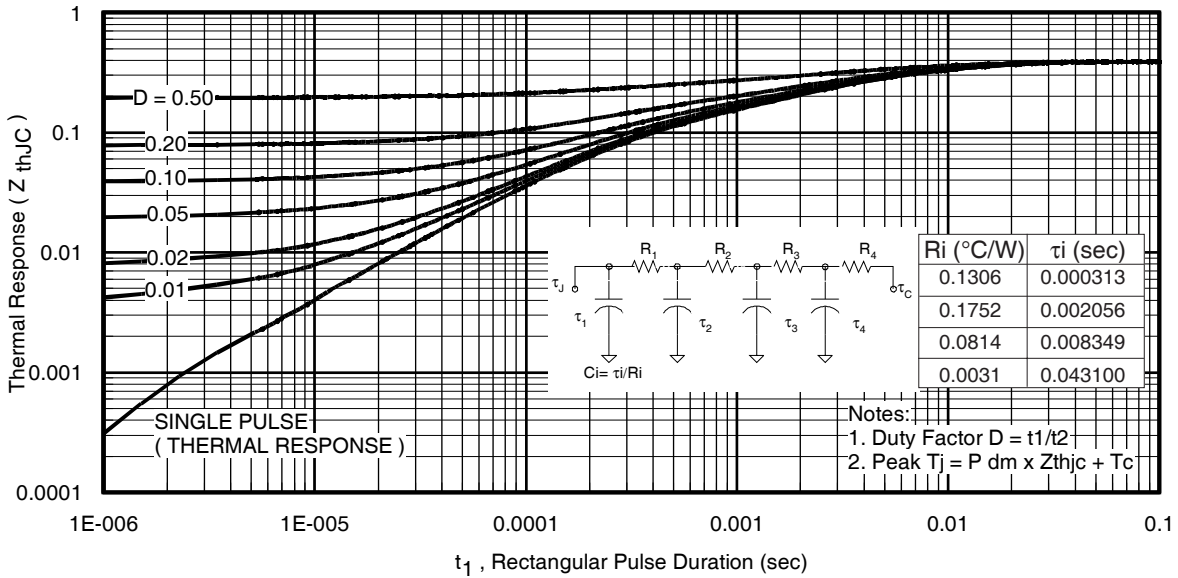

Fig. 24. Maximum Transient Thermal Impedance, Junction-to-Case (IGBT)

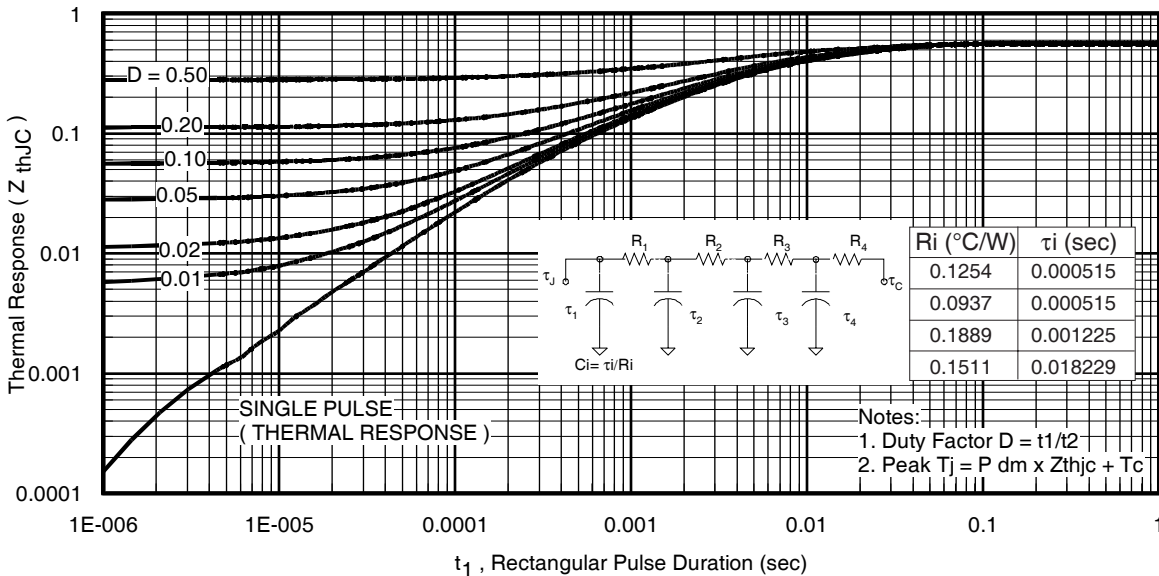

Fig. 25. Maximum Transient Thermal Impedance, Junction-to-Case (DIODE)

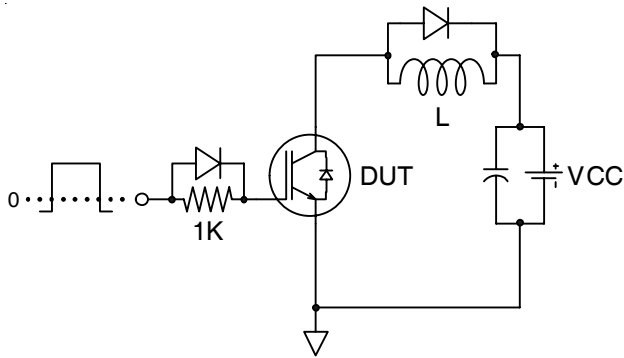

Fig.C.T.1 - Gate Charge Circuit (turn-off)

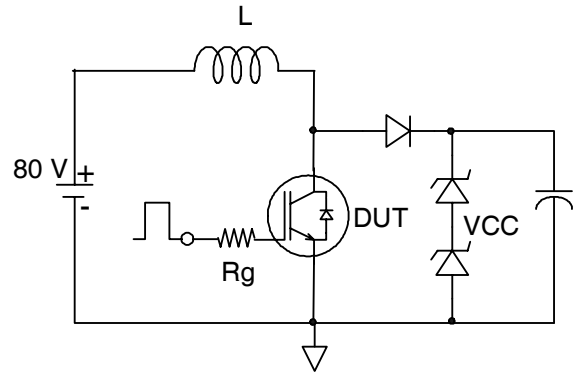

Fig.C.T.2 - RBSOA Circuit

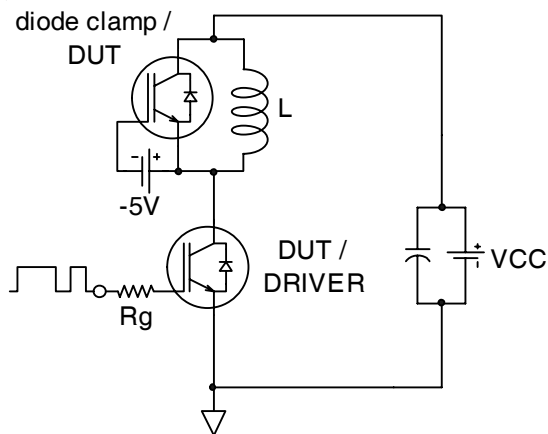

Fig.C.T.3 - Switching Loss Circuit

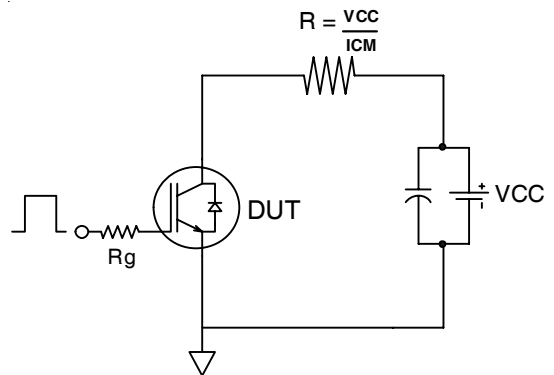

Fig.C.T.4 - Resistive Load Circuit

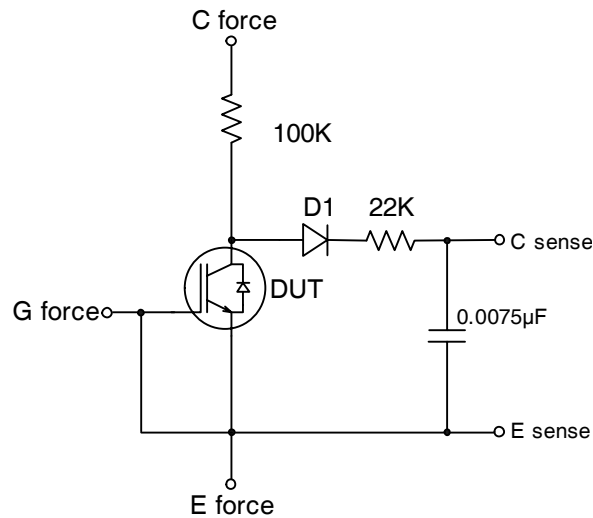

Fig.C.T.5 - BVCEs Filter Circuit

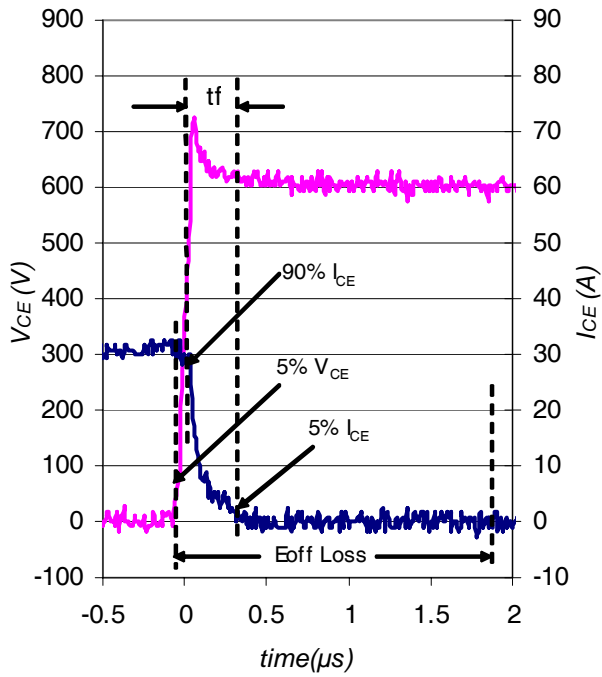

Fig. WF1 - Typ. Turn-off Loss Waveform
 @ $T_J = 150^\circ\text{C}$ using Fig. CT.4

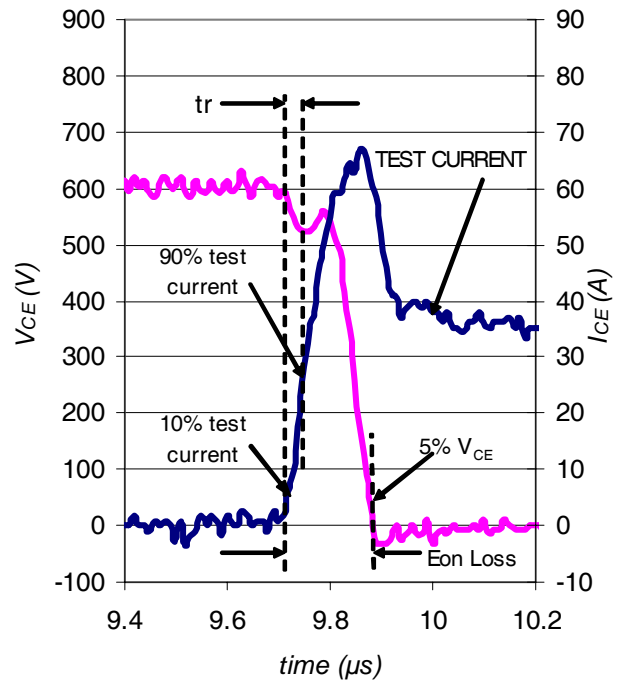

Fig. WF2 - Typ. Turn-on Loss Waveform
 @ $T_J = 150^\circ\text{C}$ using Fig. CT.4

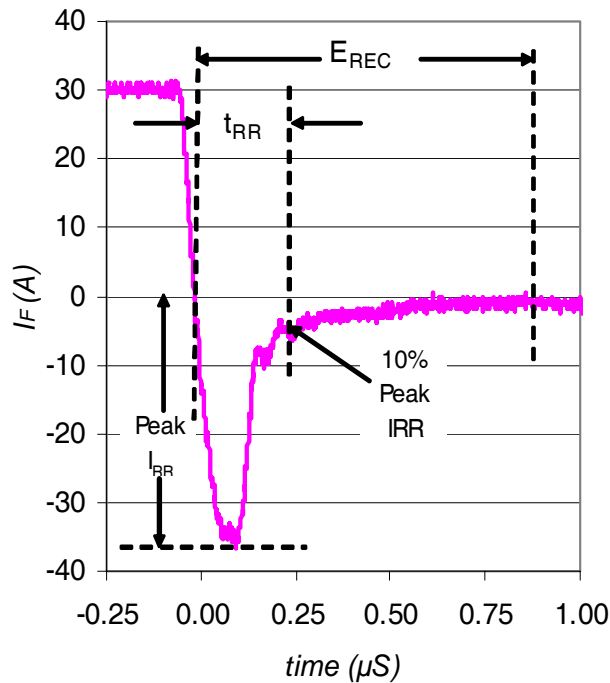
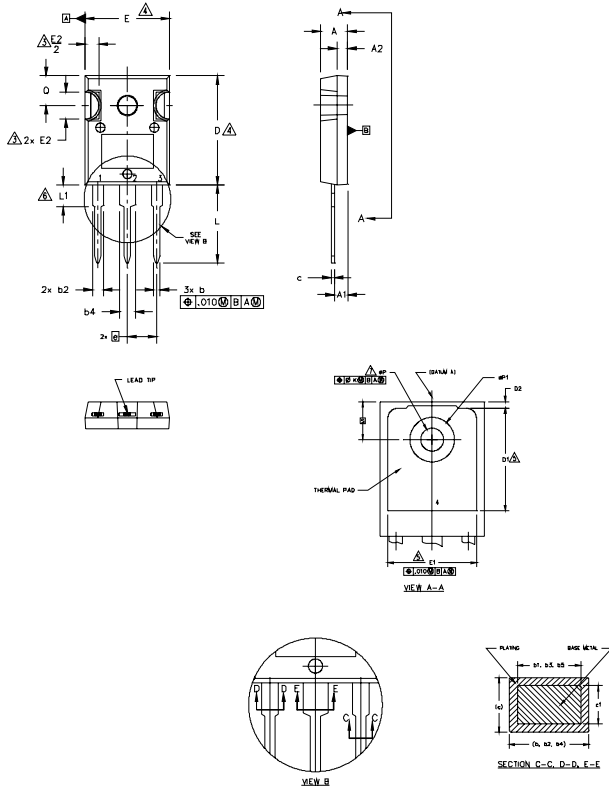

Fig. WF3 - Typ. Diode Recovery Waveform
 @ $T_J = 150^\circ\text{C}$ using Fig. CT.4

IRG7PH42UDPbF/IRG7PH42UD-EP

TO-247AC Package Outline

Dimensions are shown in millimeters (inches)



- NOTES:
1. DIMENSIONING AND TOLERANCING AS PER ASME Y14.5M 1994.
 2. DIMENSIONS ARE SHOWN IN INCHES.
 3. CONTOUR OF SLOT OPTIONAL.
 4. DIMENSION D & E DO NOT INCLUDE MOLD FLASH. MOLD FLASH SHALL NOT EXCEED .005" (0.127) PER SIDE. THESE DIMENSIONS ARE MEASURED AT THE OUTERMOST EXTREMES OF THE PLASTIC BODY.
 5. THERMAL PAD CONTOUR OPTIONAL WITHIN DIMENSIONS D1 & E1.
 6. LEAD FINISH UNCONTROLLED IN L1.
 7. ϕP TO HAVE A MAXIMUM DRAFT ANGLE OF 1.5° TO THE TOP OF THE PART WITH A MAXIMUM HOLE DIAMETER OF .154 INCH.
 8. OUTLINE CONFORMS TO JEDEC OUTLINE TO-247AC .

SYMBOL	DIMENSIONS				NOTES
	INCHES		MILLIMETERS		
	MIN.	MAX.	MIN.	MAX.	
A	.183	.209	4.65	5.31	
A1	.087	.102	2.21	2.59	
A2	.059	.098	1.50	2.49	
b	.039	.055	0.99	1.40	
b1	.039	.053	0.99	1.35	
b2	.065	.094	1.65	2.39	
b3	.065	.092	1.65	2.34	
b4	.102	.135	2.59	3.43	
b5	.102	.133	2.59	3.38	
c	.015	.035	0.38	0.89	
c1	.015	.033	0.38	0.84	
D	.776	.815	19.71	20.70	4
D1	.515	-	13.08	-	5
D2	.020	.053	0.51	1.35	
E	.602	.625	15.29	15.87	4
E1	.530	-	13.46	-	
E2	.178	.216	4.52	5.49	
e	.215 BSC		5.46 BSC		
ek	.010		0.25		
L	.559	.634	14.20	16.10	
L1	.146	.169	3.71	4.29	
ϕP	.140	.144	3.56	3.66	
$\phi P1$	-	.291	-	7.39	
Q	.209	.224	5.31	5.69	
S	.217 BSC		5.51 BSC		

LEAD ASSIGNMENTS

HEXFET

- 1.- GATE
- 2.- DRAIN
- 3.- SOURCE
- 4.- DRAIN

IGBTs, CoPACK

- 1.- GATE
- 2.- COLLECTOR
- 3.- EMITTER
- 4.- COLLECTOR

DIODES

- 1.- ANODE/OPEN
- 2.- CATHODE
- 3.- ANODE

TO-247AC Part Marking Information

EXAMPLE: THIS IS AN IRFPE30
WITH ASSEMBLY
LOT CODE 5657
ASSEMBLED ON WW 35, 2001
IN THE ASSEMBLY LINE "H"

Note: "P" in assembly line position
indicates "Lead-Free"

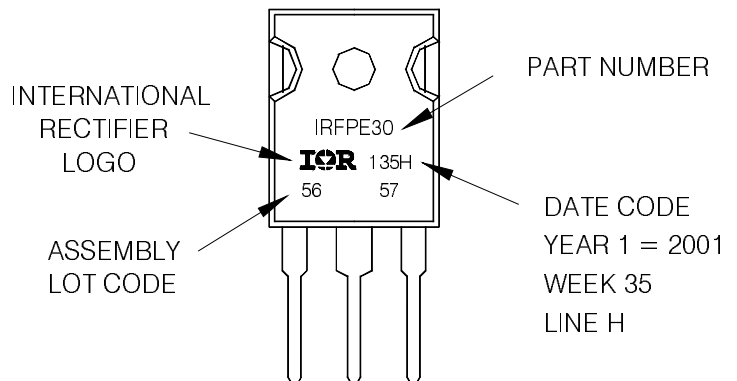

TO-247AC package is not recommended for Surface Mount Application.

Note: For the most current drawing please refer to IR website at <http://www.irf.com/package/>

TO-247AD Package Outline

Dimensions are shown in millimeters (inches)

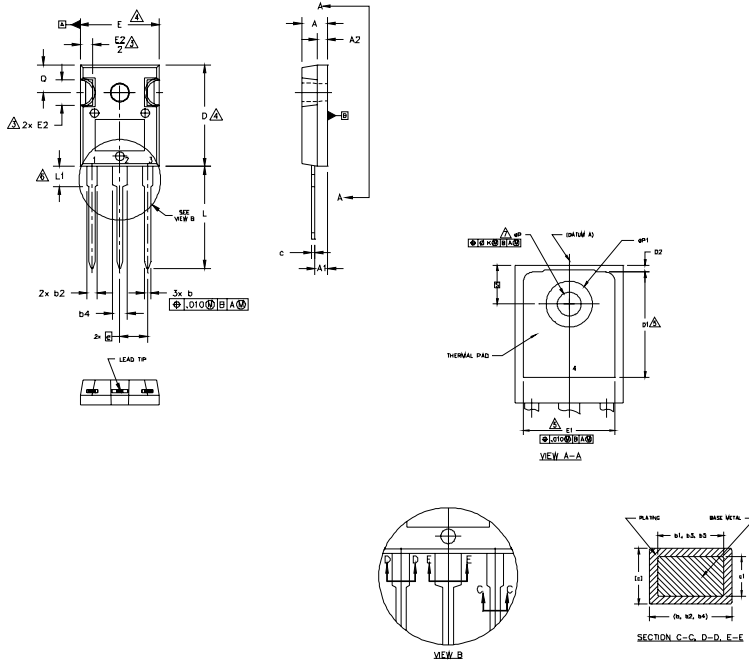

NOTES:

1. DIMENSIONING AND TOLERANCING AS PER ASME Y14.5M 1994.
2. DIMENSIONS ARE SHOWN IN INCHES.
3. CONTOUR OF SLOT OPTIONAL.
4. DIMENSION D & E DO NOT INCLUDE MOLD FLASH. MOLD FLASH SHALL NOT EXCEED .005" (0.127) PER SIDE. THESE DIMENSIONS ARE MEASURED AT THE OUTERMOST EXTREMES OF THE PLASTIC BODY.
5. THERMAL PAD CONTOUR OPTIONAL WITHIN DIMENSIONS D1 & E1.
6. LEAD FINISH UNCONTROLLED IN L1.
7. ØP TO HAVE A MAXIMUM DRAFT ANGLE OF 1.5° TO THE TOP OF THE PART WITH A MAXIMUM HOLE DIAMETER OF .154 INCH.
8. OUTLINE CONFORMS TO JEDEC OUTLINE TO-247AD.

SYMBOL	DIMENSIONS				NOTES
	INCHES		MILLIMETERS		
	MIN.	MAX.	MIN.	MAX.	
A	.183	.209	4.65	5.31	
A1	.087	.102	2.21	2.59	
A2	.059	.098	1.50	2.49	
b	.039	.055	0.99	1.40	
b1	.039	.053	0.99	1.35	
b2	.065	.094	1.65	2.39	
b3	.065	.092	1.65	2.34	
b4	.102	.135	2.59	3.43	
b5	.102	.133	2.59	3.38	
c	.015	.035	0.38	0.89	
c1	.015	.033	0.38	0.84	
D	.776	.815	19.71	20.70	4
D1	.515	-	13.08	-	5
D2	.020	.053	0.51	1.35	
E	.602	.625	15.29	15.87	4
E1	.530	-	13.46	-	
E2	.178	.216	4.52	5.49	
e	.215 BSC		5.46 BSC		
Øk	.010		0.25		
L	.780	.827	19.57	21.00	
L1	.146	.169	3.71	4.29	
ØP	.140	.144	3.56	3.66	
ØP1	-	.291	-	7.39	
Q	.209	.224	5.31	5.69	
S	.217 BSC		5.51 BSC		

LEAD ASSIGNMENTS

HEXFET

- 1.- GATE
- 2.- DRAIN
- 3.- SOURCE
- 4.- DRAIN

IGBTs, CoPACK

- 1.- GATE
- 2.- COLLECTOR
- 3.- EMITTER
- 4.- COLLECTOR

DIODES

- 1.- ANODE/OPEN
- 2.- CATHODE
- 3.- ANODE

TO-247AD Part Marking Information

EXAMPLE: THIS IS AN IRGP30B120KD-E
WITH ASSEMBLY
LOT CODE 5657
ASSEMBLED ON WW 35, 2000
IN THE ASSEMBLY LINE "H"

Note: "P" in assembly line position
indicates "Lead-Free"

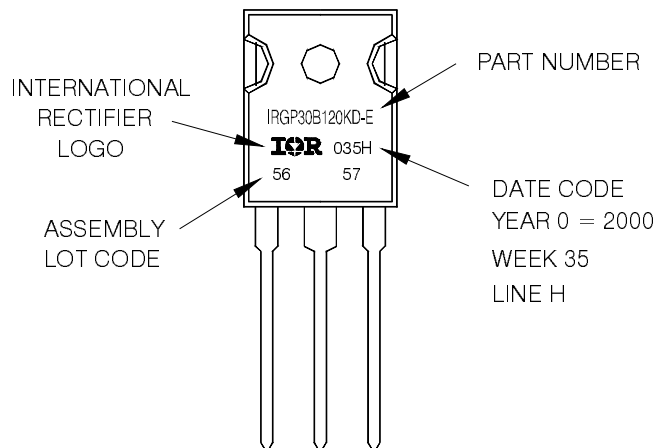

TO-247AD package is not recommended for Surface Mount Application.

Note: For the most current drawing please refer to IR website at <http://www.irf.com/package/>

Data and specifications subject to change without notice.
This product has been designed and qualified for Industrial market.
Qualification Standards can be found on IR's Web site.